

Please go to [www.quoizel.com](http://www.quoizel.com) for product cleaning tips. Go to the **Care + Maintenance** selection.

**Tools Required:** Flathead screwdriver, Phillips screwdriver, pliers, wire cutters, wire strippers, electrical tape, safety glasses.

**Light Source:** (6) G9 Xenon Clear Bulbs (supplied), 40W Maximum

**Estimated Assembly Time:** 30-45 minutes

**Preparation:** Identify and inspect all parts before beginning installation. Check package content list and diagrams below to be sure all parts are present. If any parts are missing or damaged, do not attempt to assemble, install, or operate the fixture. Contact customer service for replacement parts.

### ⚠ Warnings and Cautions

Turn off electricity at circuit breaker or main fuse box before installation. Consult a licensed electrician if in doubt.

These instructions are provided for your safety. It is very important you read them completely before installing the fixture. We strongly recommend that a licensed, professional electrician perform the installation.

Disconnect fixture from power source before replacing bulbs. Make sure bulbs are given sufficient time to cool before removal. Do not subject glass parts to any shock while in operation or shattering may result.

Do not touch the bulb with bare hands use a cloth or glove.

### Package Contents

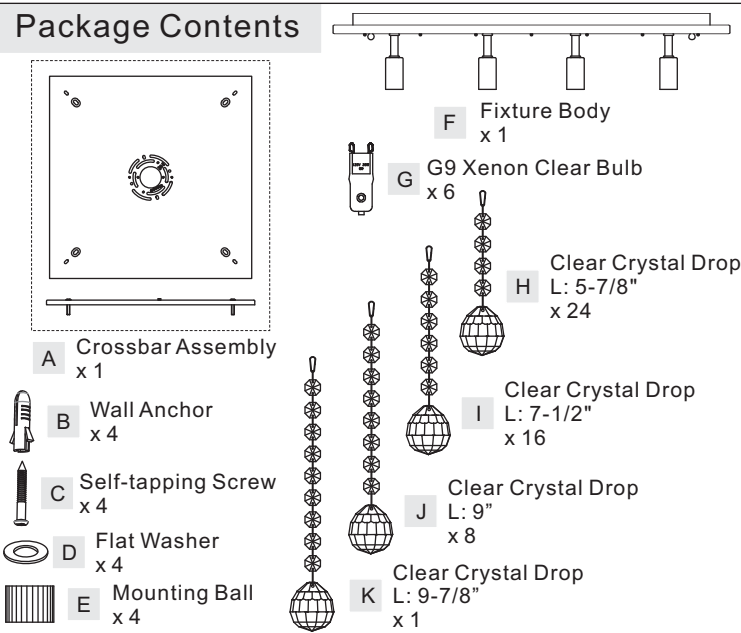

### STEP 1 - Attach Inner Backplate to Outlet Box

- Place the Crossbar Assembly (A) onto the Ceiling surface and line up one set of holes onto mounting holes on Outlet Box. Using a pencil, mark the locations for Wall Anchors (B).
- Remove the Crossbar Assembly (A) and drill holes from the marks and then push the Wall Anchors (B) into the holes.
- Position the Crossbar Assembly (A) back onto the Ceiling. Thread the Outlet Box Screws (not supplied) into the mounting holes on the Outlet Box to secure it. Hand tighten until snug.
- Pass the Flat Washers (D) over the Self-tapping screws (C) and then thread the self-tapping screws (C) into the Wall Anchors (B). Hand tighten until snug.

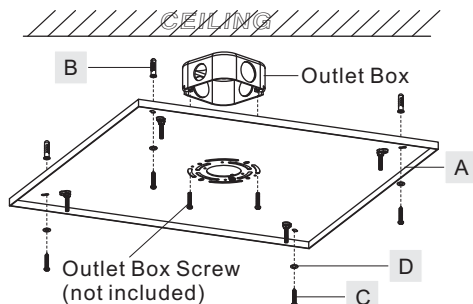

### STEP 2 - Wire Connections

- Use standard wire connectors (not included) to make all wire connections. (Connectors are not included with fixture.) Twist connectors until wires are tightly joined together. Wrap each connection with approved electrical tape and carefully stuff all the connected wires into the Outlet Box.

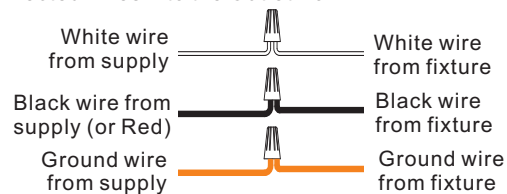

### STEP 3 - Attach Ceiling Canopy to Mounting Screw

- Remove Protective Film from Ceiling Canopy. Note: Gloves are required to avoid leaving fingerprints or scratches on Ceiling Canopy.
- Place the Ceiling Canopy on the Fixture Body (F) over the Mounting Screws and secure with Mounting Balls (E). Hand tighten until snug.

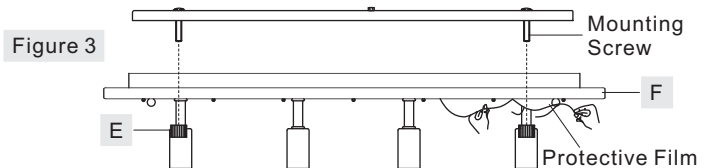

### STEP 4 - Install Bulb

- This fixture uses G9 Xenon Clear Bulbs (G). Maximum 40 watts. Insert bulb and seat properly into place.

**IMPORTANT:** Do not touch the bulb with bare hands use a cloth or glove.

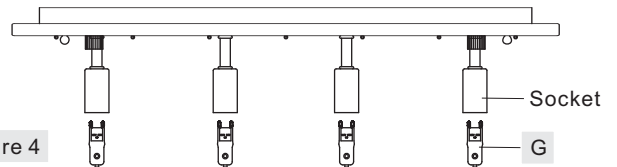

### STEP 5 - Install Crystal to Fixture

- (Refer to **Crystal Distribution**) Attach Clear Crystal Drop L9-7/8" (K) to location "D" on the center of the Ceiling Canopy. Attach Clear

Thank you for purchasing a Quoizel product.  
Need assistance with parts or assembly? Call Quoizel customer service at 1-631-273-2700  
or visit us on-line at [www.quoizel.com](http://www.quoizel.com)

**(Step 5 Continued)**

Crystal Drops L9" (J) to locations "C" on the Ceiling Canopy. Attach Clear Crystal Drops L7-1/2" (I) to locations "B" on the Ceiling Canopy. Attach Clear Crystal Drops L5-7/8" (H) on locations "A" on the Ceiling Canopy.

Your fixture is now assembled and ready to use. Enjoy!

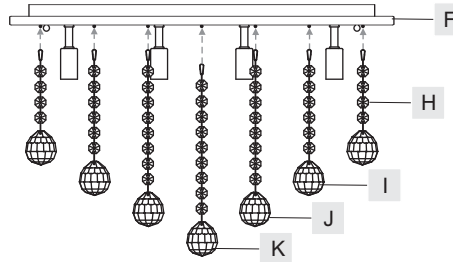
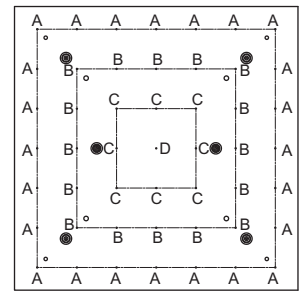

Figure 5



**Crystal Distribution**

**CAUTION FOR BULB REPLACING**

- A. When replace bulb, turn off power and allow lamp to cool. For safety purpose, wear gloves and eye protection.
- B. If bulb is scratched or cracked, DO NOT use the lamp to avoid breakage during use or installation.
- C. Use only in fixtures rated for lamps wattage and voltage.
- D. Lamp operate under high pressure generating intense heat. Prevent contact with liquid and combustible materials.

BRX1620C  
FINISH: POLISHED CHROME

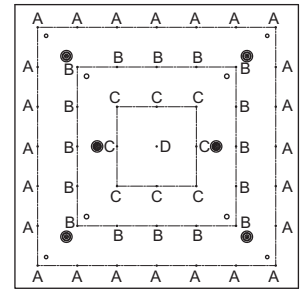
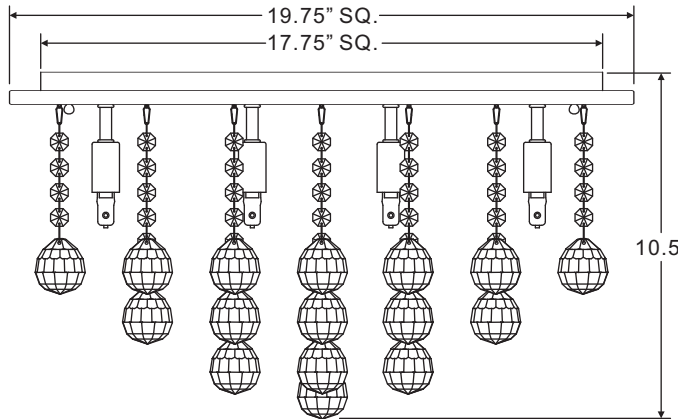
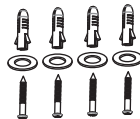
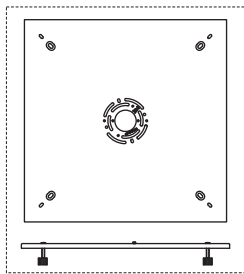

**Crystal Distribution**

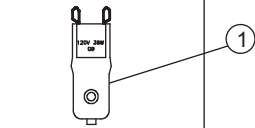

(6) 40W Maximum G9 Xenon Clear Bulbs (Supplied)

NOTE: ALL DIMENSIONS ARE ROUNDED UP TO THE NEAREST 1/4"

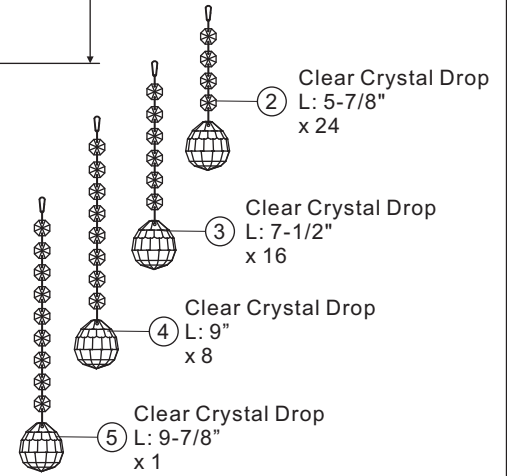

NO.	PART NUMBER	REPLACEMENT PART DESCRIPTION	REQ.
1	I1202SC	G9 XENON CLEAR BULB	6
2	G12197CR	CLEAR CRYSTAL DROP L: 5-7/8"	24
3	G2350CR	CLEAR CRYSTAL DROP L: 7-1/2"	16
4	G2351CR	CLEAR CRYSTAL DROP L: 9"	8
5	G2352CR	CLEAR CRYSTAL DROP L: 9-7/8"	1

Thank you for purchasing a Quoizel product.  
Need assistance with parts or assembly? Call Quoizel customer service at 1-631-273-2700  
or visit us on-line at [www.quoise.com](http://www.quoise.com)