

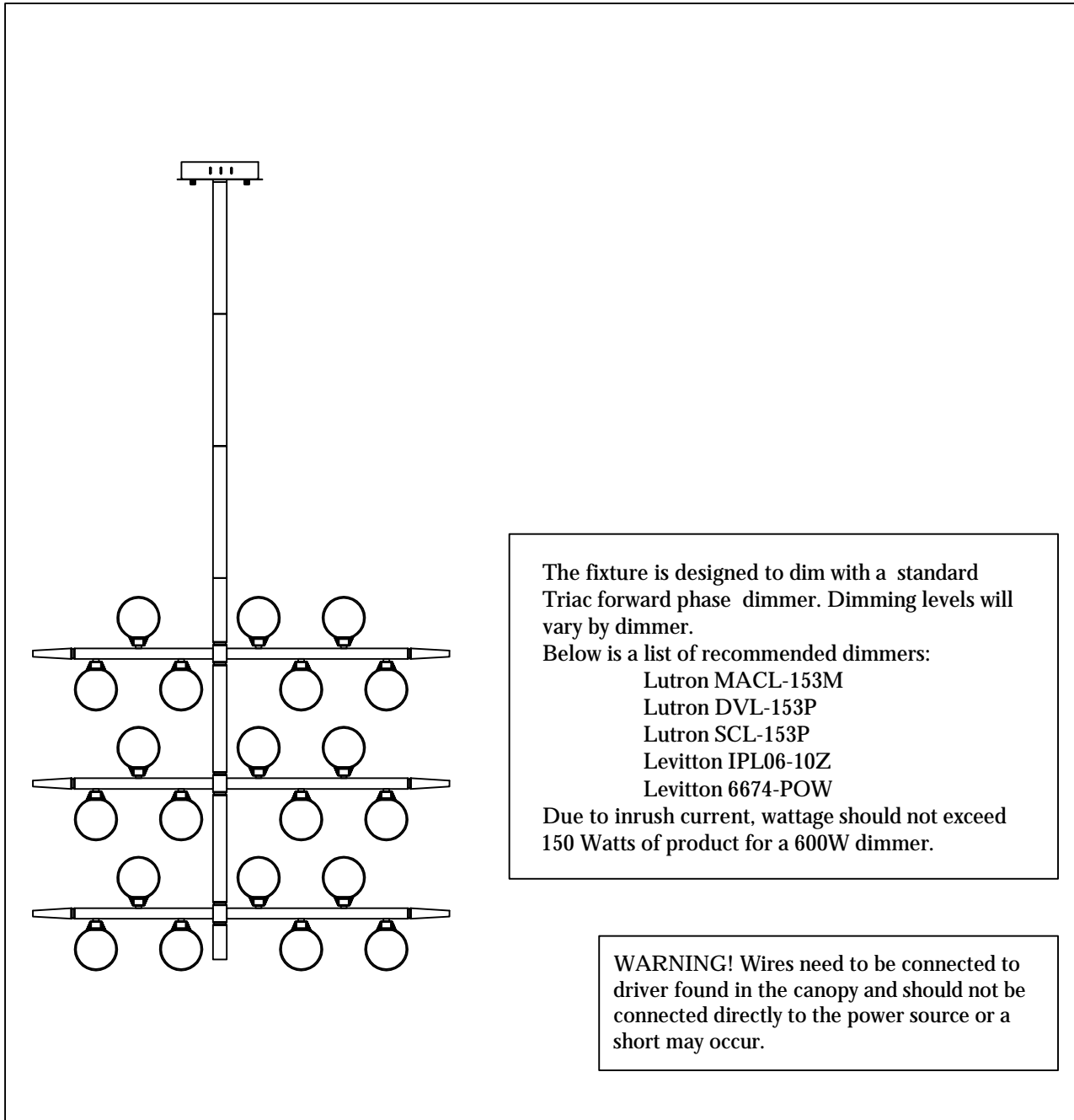

Contemporary
Lighting™

PRODUCT NAME: Bubbly
ITEM NUMBER: E24573-91PC

Please consult your electrician for hanging fixture and wiring.



The fixture is designed to dim with a standard Triac forward phase dimmer. Dimming levels will vary by dimmer.

Below is a list of recommended dimmers:

Lutron MACL-153M

Lutron DVL-153P

Lutron SCL-153P

Leviton IPL06-10Z

Leviton 6674-POW

Due to inrush current, wattage should not exceed 150 Watts of product for a 600W dimmer.

WARNING! Wires need to be connected to driver found in the canopy and should not be connected directly to the power source or a short may occur.

21* 2.5W PCB LED

IMPORTANT: Turn off the power at the main fuse or circuit breaker box before starting installation

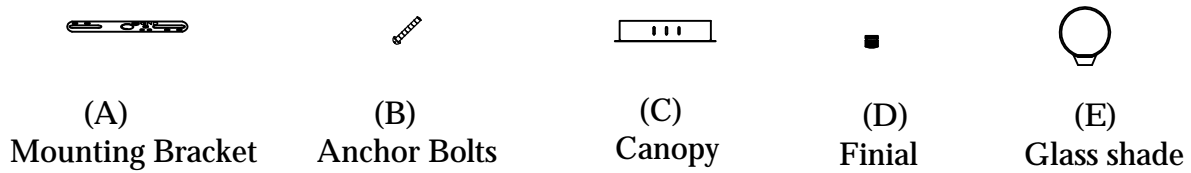

Locate all hardware & components before discarding packaging

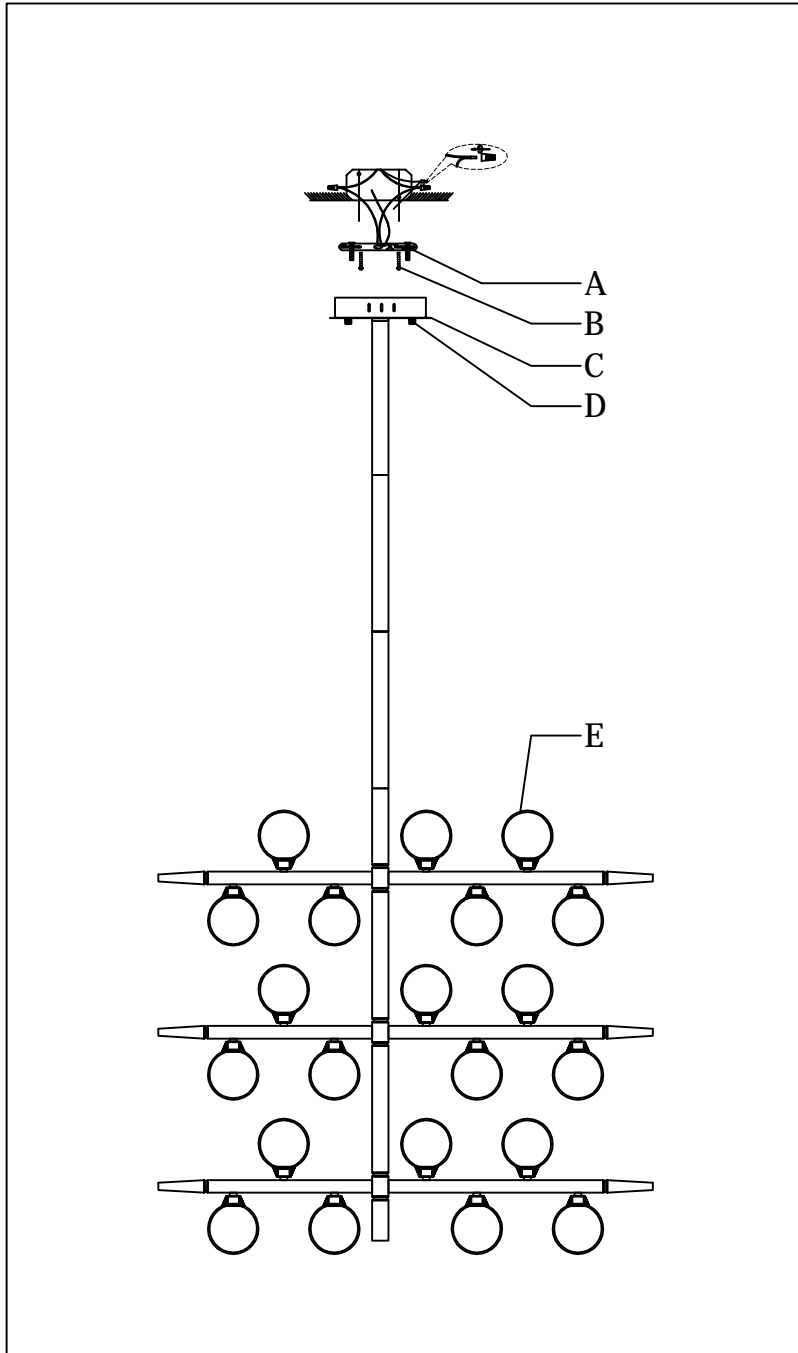

Cleaning & Care:
Clean with soft cloth and a mild detergent.
Do not use abrasive cleaner.

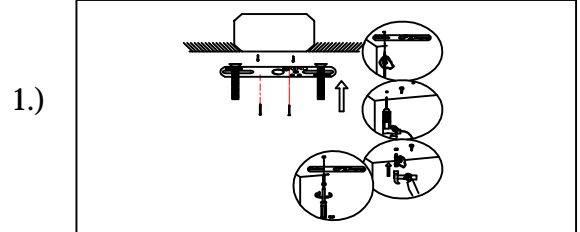

1.)
Step.1: Remove mounting bracket (A) and install to electrical box. Mark where anchors meet ceiling, remove mounting bracket from ceiling, and then drill holes using $\frac{3}{16}$ " drill bit where marked (B). Install mounting bracket and attach anchors to secure bracket at ends.

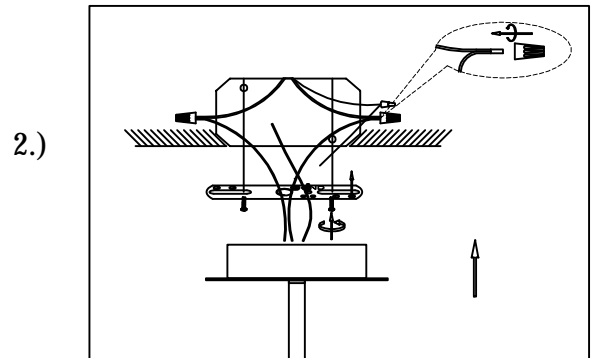

2.)
Step.2: Run wire through stems and combine stem lengths to meet desired mounting height. Wire fixture to wires in outlet box. Green/copper wire is for ground.

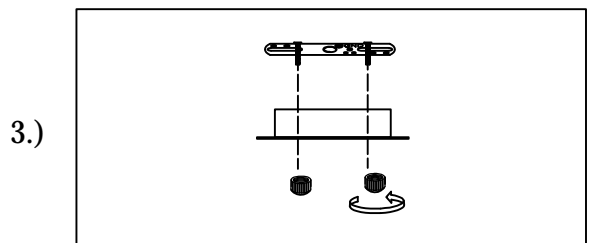

3.)
Step.3: Screw finials (D) onto mounting bracket (A) until canopy is flush with ceiling.

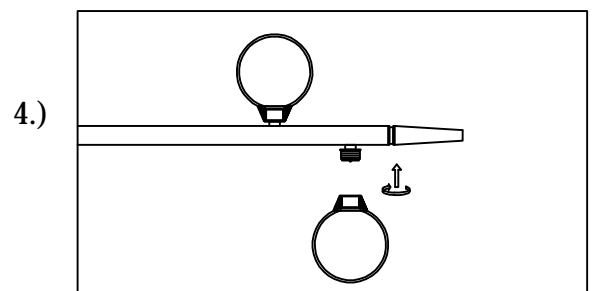

4.)
Step.4: Screw the glass shade (E) to the socket as above diagram.