



Contemporary  
Lighting™

**PRODUCT NAME :** Moonbeam LED

**ITEM NUMBER:** E22445-11MS

**Please consult your electrician for hanging fixture and wiring.**

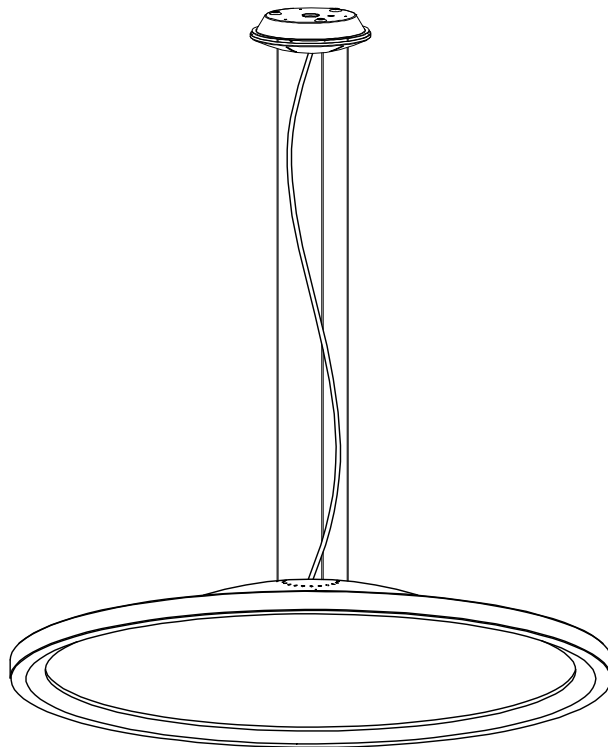

**WARNING: WIRES NEED TO BE CONNECTED TO DRIVER FOUND IN CANOPY AND SHOULD NOT CONECT DIRECTLY TO POWER SOURCE OR A SHORT MIGHT OCCUR.**

The fixture is designed to dim with a standard Triac forward phase dimmer. Dimming levels will vary by dimmer.

Below is a list of recommended dimmers:

Lutron MACL-153M  
Lutron DVL-153P  
Lutron SCL-153P  
Leviton IPL06-10Z  
Leviton 6674-POW

**Due to the inrush current wattage should not exceed 150 watts of product for a 600 watt dimmer.**

**27W LED**

**IMPORTANT: Turn off the power at the main fuse or circuit breaker box before starting installation**

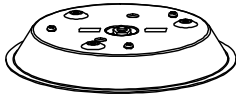

Bracket (A)

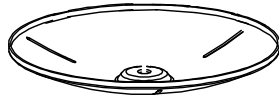

Canopy (B)



Body (C)

**Locate all hardware & components before discarding packaging**

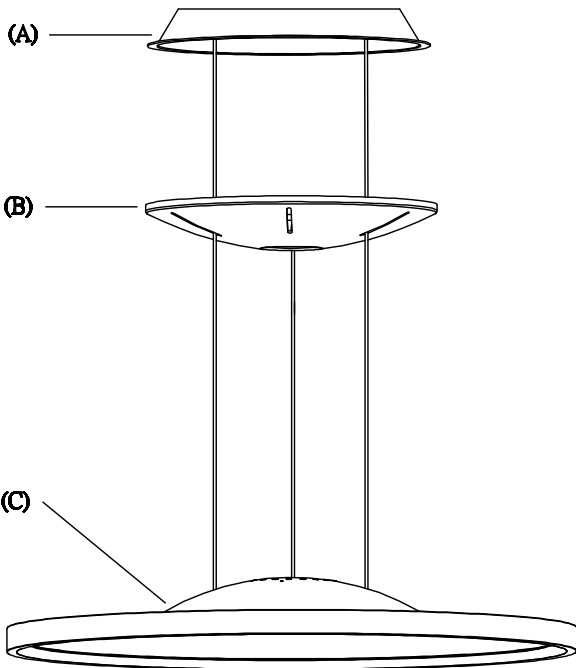

1.)

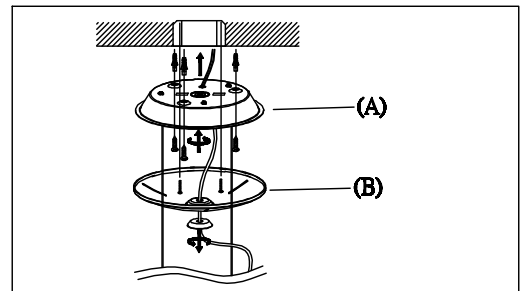

**Step.1: Remove Bracket (A) from fixture and install to electrical box.**

2.)

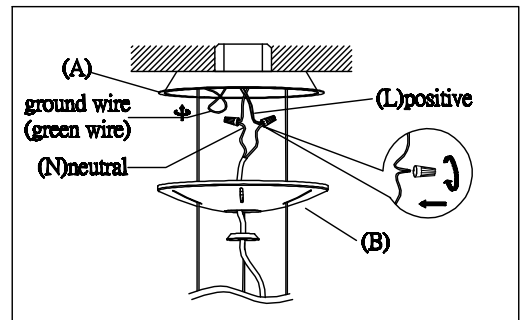

**Step.2: Wire fixture to wires in outlet box. Install Green wire to Ground Screw.**

3.)

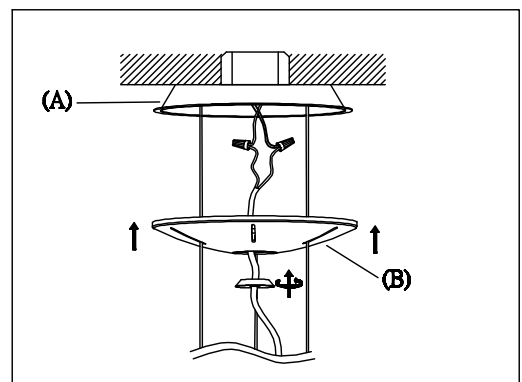

**Step 3: Adjust wire length to desired hanging height. Install Canopy (B) to Bracket (A) and tighten screws at the ends of canopy to secure.**

**Cleaning & Care:**

Clean with soft cloth and a mild detergent.  
Do not use abrasive cleaner.